

INSTALLATION / WARRANTY INSTRUCTIONS

PRODUCT BRAND: PIERLITE

PRODUCT NAME: TABLET WALL LIGHT GEN3

PRODUCT CODE: TABLDI830BG3 TABL830BG3

Issue Date: 08/31/2023

Please read these installation instructions carefully before installing or maintaining this equipment. The product is designed for installation and maintenance in accordance with relevant Australian standards (AS/NZ3000), by an authorised and licensed electrician. The installation instructions were correct at the time of print. To reflect changes in technology and Australian and New Zealand standards; Pierlite reserves the right to amend the instructions without notice. Updated guidelines can be found on relevant brand web site.



1. PRODUCT SPECIFICATION:

| | |
|-------------------------------------|--|
| Type of protection | Class I luminaire |
| Type of protection | IP65 |
| Nominal voltage | 220 - 240Vac |
| Nominal frequency | 50/60Hz |
| Line current | 40mA@7W 25mA@4W |
| Available wattages | 7W@Up&Down 4W@Down only |
| Power factor | ≥0.8 |
| Surge protection rating | L-N: 1KV |
| Inrush current | ≤15A/200us(230VAC~ Full-load) |
| Earth leakage | <0.7mA |
| Rated operating ambient temperature | -20°C to 40°C |
| LED lifetime | Rated 54000 hours (L70/B10) +40°C Calculated >497000 hours (L70/B10) @+40° Rated 54000 hours (L90/B10) +40°C Calculated >147000 hours (L90/B10) @+40° |
| Emergency battery design life | N/A |
| Colour temperature | 3000K |
| Colour rendering index (CRI) | 80 |
| LED control gear | Built-in LED driver |
| Available in emergency | N/A |
| Emergency battery technology | N/A |
| Electrical connection | PA14H Terminal Block |
| Cable entry | 20AWG~8AWG |
| Installation type | Wall mounted |
| Dimensions (LxWxH) | 170.5 x 94.6 x 59.5mm |
| Net weight of luminaire | 0.695kgs@Up&Down 0.617kgs@Down only |
| Warranty | Luminaire: 5 years |
| Suitability | Outdoor / Indoor |

2. LINE DIAGRAMS AND DIMENSIONS

| Length (mm) | Width (mm) | Height (mm) | Weight in (kg) | |
|-------------|------------|-------------|------------------|--------------------|
| 170.5 | 94.6 | 59.5 | 0.695kgs@Up&Down | 0.617kgs@Down only |

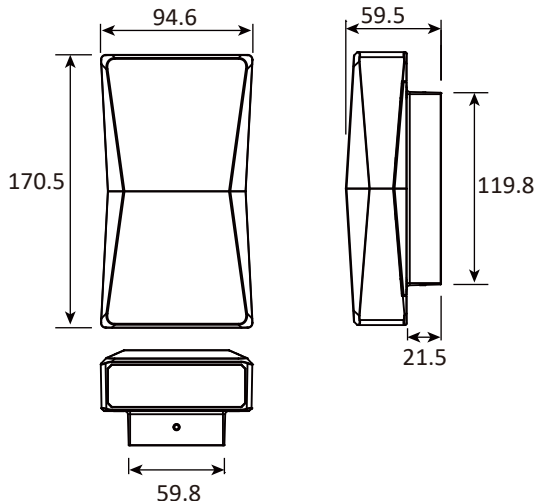

3. INSTALLATION / GENERAL: Installation of the product is to be completed by an authorized and licensed electrician, in accordance with these instructions, relevant Australia standards and local regulations (where applicable). Termination of product wiring, together with the installation of the product must be in a manner and orientation that maintains the integrity of the designated IP rating of the product for electronic control equipment (when supplied) DO NOT MEGGER between A and N.

Warning: The light source contained in this luminaire shall only be replaced by the manufacturer or his service agent or a similar qualified person.

Installation:

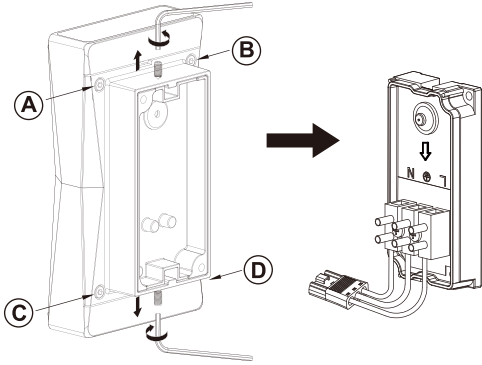
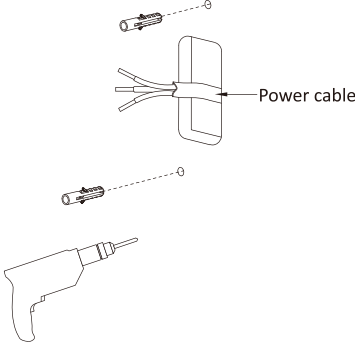
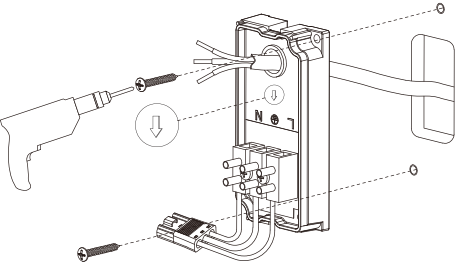
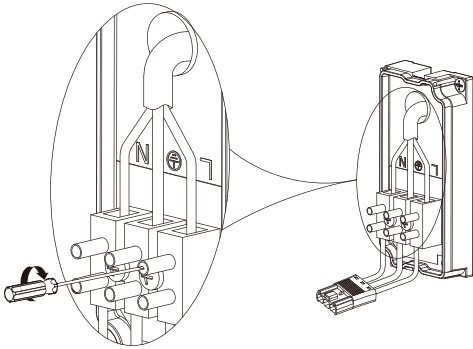
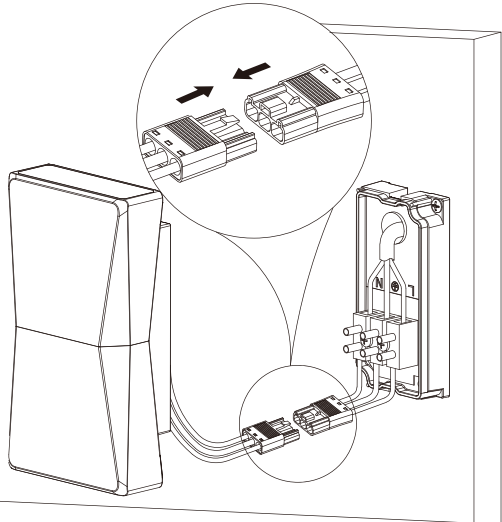
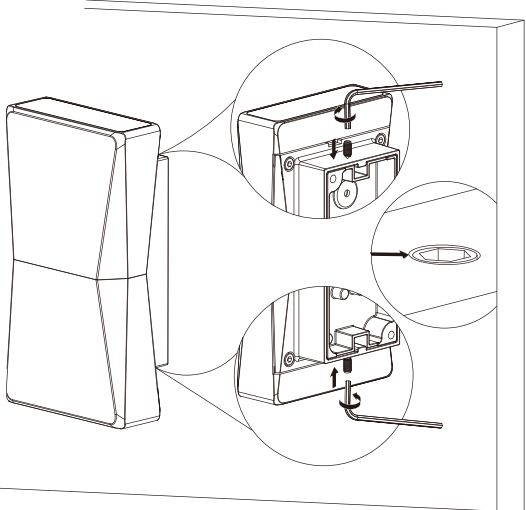
| | |
|--|---|
|  <p>1. Unfasten top and bottom screws and take out the back cover. Please do not unfasten 4 screws as shown as A,B,C,D</p> |  <p>2. Switch off the power, and drill the mounting holes on the wall and insert the expansion screw sockets.</p> |
|  <p>3. Pass the power cable through the grommet and mount the back cover on the wall. ATTENTION: for single head, the direction of the arrow on the body is same as light direction.</p> |  <p>4. Connect L/N/E cable to the terminal block firmly.</p> |
|  <p>5. Connect the quick connector between back cover and body.</p> |  <p>6. Align the body and back cover carefully and lock the top and bottom screws.</p> |

IMPORTANT - the product must be maintained and operated in accordance with the manufacturer's instructions, failure to do so may damage the product and services. It is strongly recommended that this important note be communicated to the owner and/or operator of the installation at the time of site commissioning. Good practice does not recommend the 24/7 use of products without the application of suitable switch cycle intervals. Furthermore, with the omission of nominated survival curves and/or recommended operating hours, product design expectations provide for a continual daily usage of 6 hours for residential applications and a continual daily usage of 12 hours for commercial and industrial applications. All products must be thoroughly cleaned on a regular basis at intervals that reflect in the installation environment, ensuring the optical performance, together with the electrical, mechanical, and structural integrity as designed, is maintained throughout the service life of the product.

APPROVALS: The RCM marking of this product applies to AS/NZS CISPR15 (EMC) "Limits and methods of measurement of radio disturbance characteristics of electrical lighting and similar equipment". This product is designed to conform to AS/NZS60598 "Luminaires, general requirements and tests".



STORAGE: Prior to installation products are to be stored in cool and dry conditions.

APPLICATION: The installation application and orientation of the product is designed in accordance with the nominated product IP rating, class designation and these installation installations. Installation environments outside these conditions are not recommended.

MAINTENANCE:

(a) The supply must be isolated before opening or accessing the luminaire. Product maintenance is IMPORTANT and is critical to the products designed performance. The product is to be maintained in accordance with the manufacturer's instructions. For the latest product maintenance guides please go to relevant brand web site. Pierlite is not responsible for any product not maintained in accordance with the recommended procedure or intervals.

(b) **Lamps (where provided):** The product is designed with the supplied (LEDs) / LAMP/s and it is strongly recommended that any LAMP / (LEDs) changes (if any) be made in accordance with the type, colour and brand supplied. For recommended LAMP / LED maintenance or operating guides (inclusive of recommended product switch cycles and mandatory run-in procedures for HID and Fluorescent lamps when used with dimming circuits), Pierlite recommends the application of the lamp manufacturer's operating guidelines, which can be found on manufacturer's website. Pierlite is not responsible for the product performance of alternative lamp/s used. As a member of FluroCycle, we encourage recycling of lamps and components.

(c) **Cables or cords,** If Any external cable or cord of the X or Y type luminaire is damaged, it shall be replaced by a qualified person or manufacturer's service agent.

For Z type attachments to luminaire, cord cannot be replaced if damaged, the luminaire shall be removed from service.

Flex cord types.

- X: A specially prepared flexible cable or cord, may also include a part of the luminaire and only available from manufacture.
- Y: Attachment may be used either with ordinary or special flexible cable or cord.
- Z: Attachment of cable or cord that cannot be replaced without damage to luminaire

WARRANTY INSTRUCTIONS: For the purpose of warranty claims (if any) the following instructions apply:

Warranty period - The above components are provided with a warranty (refer to product specifications for details) against manufacturing defects or failure to perform to specifications for products installed by an authorised installer in accordance with the manufacturer's installation instructions and which have not been subject to incorrect operation or maintenance, unauthorised modification or damage arising from any intervening cause.

Warranty reference - The warranty reference date commences from the date of purchase.

Warranty point of contact - Pierlite, 96 Gow Street Padstow NSW 2211, phone T 1300 799 300 contact - Pierlite After Sales Support.

Warranty claim procedure - For the purpose of making a claim the customer must:

1. Contact the "point of contact" above and upon provision of proof of purchase the customer will receive a goods return advice (GRA) number.
2. At the customer's expense, collect and return the goods to the "point of contact" with the issued GRA number.
3. Upon receipt of the goods, Pierlite will review the claim and if found to be accepted, Pierlite will return a replacement product to the customer to install at the customer's expense. Alternatively, if the claim is rejected, the customer may request the return of the goods at their expense.

Consumer Contracts - The benefits to the customer given by the Pierlite warranty are in addition to other rights and remedies of the customer if the goods are the subject of a Consumer Contract under the Australian Consumer Law. In that event the following statement is required to be brought to the Consumer's attention: - *Our goods come with guarantees that cannot be excluded under the Australian Consumer Law. You are entitled to a replacement or refund for a major failure and for compensation for any other reasonably foreseeable loss or damage. You are also entitled to have the goods repaired or replaced if the goods fail to be of acceptable quality and the failure does not amount to a major failure.*

Limitation of Liability - if the goods are not purchased by the customer under a Consumer Contract within the Australian Consumer Law then but not otherwise;- (a) the Company is not liable in tort for any loss or damage suffered by the customer or by any third party; and (b) in no circumstances is Pierlite liable to the customer or to any third party for any loss of profits, loss of anticipated savings, economic loss or interruption of business or for any indirect or consequential loss (Consequential Loss).

Terms of Sale - these warranty provisions are in substitution for any inconsistent provisions in the Pierlite Terms and Conditions of Sale in so far as they apply to the warranty components.