

Pierlite Eco LED Panel Gen2

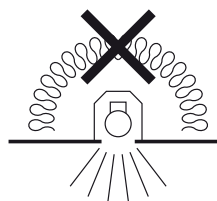

PLEASE READ THESE INSTALLATION INSTRUCTIONS CAREFULLY BEFORE INSTALLING OR MAINTAINING THIS EQUIPMENT. THE PRODUCT IS DESIGNED FOR INSTALLATION AND MAINTENANCE IN ACCORDANCE WITH RELEVANT AUSTRALIAN STANDARDS (AS3000) AND LOCAL REGULATIONS (WHERE APPLICABLE), BY AN AUTHORISED AND LICENCED ELECTRICIAN. THE INSTALLATION INSTRUCTIONS WERE CORRECT AT THE TIME OF PRINT. TO REFLECT CHANGES IN TECHNOLOGY AND AUSTRALIAN STANDARDS; GERARD LIGHTING RESERVES THE RIGHT TO AMEND THE INSTRUCTIONS WITHOUT NOTICE. UPDATED GUIDELINES CAN BE FOUND ON THE RELEVANT BRAND WEB SITE.

IMPORTANT - THE PRODUCT MUST BE MAINTAINED AND OPERATED IN ACCORDANCE WITH THE MANUFACTURER'S INSTRUCTIONS, FAILURE TO DO SO MAY DAMAGE THE PRODUCT AND SERVICES. IT IS STRONGLY RECOMMENDED THAT THIS IMPORTANT NOTE BE COMMUNICATED TO THE OWNER AND OR OPERATOR OF THE INSTALLATION AT THE TIME OF SITE COMMISSIONING. GOOD PRACTICE DOES NOT RECOMMEND THE 24/7 USE OF PRODUCTS WITHOUT THE APPLICATION OF SUITABLE SWITCH CYCLE INTERVALS. FURTHERMORE, WITH THE OMISSION OF NOMINATED SURVIVAL CURVES AND OR RECOMMENDED OPERATING HOURS, PRODUCT DESIGN EXPECTATIONS PROVIDE FOR A CONTINUAL DAILY USAGE OF 6 HOURS FOR RESIDENTIAL APPLICATIONS AND A CONTINUAL DAILY USAGE OF 12 HOURS FOR COMMERCIAL AND INDUSTRIAL APPLICATIONS. ALL PRODUCTS MUST BE THOROUGHLY CLEANED ON A REGULAR BASIS AT INTERVALS THAT REFLECT IN THE INSTALLATION ENVIRONMENT, ENSURING THE OPTICAL PERFORMANCE, TOGETHER WITH THE ELECTRICAL, MECHANICAL AND STRUCTURAL INTEGRITY AS DESIGNED, IS MAINTAINED THROUGHOUT THE SERVICE LIFE OF THE PRODUCT.









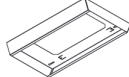

1. PRODUCT SPECIFICATION:

	ECOPL063CSEG2	ECOPL066CSEG2	ECOPL123CSEG2	ECOPL126CSEG2	ECOPL1234UG19	ECOPL1234EG2
Type of Protection	Panel with driver : Class II					
Body Material	Steel plate with Aluminium					
Finish	white powder coated					
Circuit Wattage	14W	27W	27W	50W	34W	27W
Nominal Voltage	220-240V					
Line Current	0.065A	0.123A	0.123A	0.213A	0.15A	0.123A
Nominal Freq. (Hz)	50Hz					
Power factor	>0.90					
Inrush current	2.36A/33us	2.14A/52us	2.14A/52us	4.84A/38us	2.32A/56us	2.14A/52us
Leakage current	<0.7mA	<0.7mA	<0.7mA	<0.7mA	<0.7mA	<0.7mA
Rated operating ambient temperature	40 degree celsius					
LED Lifetime (L80 B10) @ 40°C	105,000 hours					
IP Rating	IP40 from the front, IP20 from the rear IP Rating - for interior products, the IP rating nominated is "from below the ceiling" unless specifically nominated.					
Suitable for direct mounting on flammable surfaces	No					
Dimmable	No					
Installation orientation	Horizontal face down Recessed, Surface mounted, suspended Suspension kit is designed for applications, where it is not possible or desirable to surface mount or recessed the panel, it is available for stand alone panels and surface frames					
Installation type	Fixed					
Designed application	Interior commercial (Interior)					
Electrical connection	supplied with 2-pin flex and plug					
Dimensions	595mm x 295 mm x 30.3mm	595mm x 595mm x 30.3mm	1195mm x 295mm x 30.3mm	1195mm*595mm*33mm	1195mm x 295mm x 30.3mm	1195mm x 295mm x 30.3mm
Net Weight of luminaire	1.015 kg	1.927 kg	1.998 kg	4.335kg	2.319 kg	1.929kg

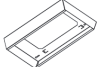
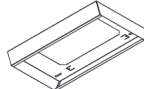
2. LUMINAIRE TABLE

Product Code	Power (W)	CRI	Lumen Output (lm) / CCT (K)	Voltage	Optics in degrees	Supply Cable
ECOPL063CSEG2	14W	>80	1400lm/4000K 1500lm/5000K 1400lm/6500K	240V	110°	1.2m flex and plug
ECOPL066CSEG2	27W	>80	2800lm/4000K 2900lm/5000K 2800lm/6500K	240V	110°	1.2m flex and plug
ECOPL123CSEG2	27W	>80	2800lm/4000K 2900lm/5000K 2800lm/6500K	240V	110°	1.2m flex and plug
ECOPL126CSEG2	50W	>80	5000lm/4000K 5300lm/5000K 5000lm/6500K	240V	110°	1.2m flex and plug
ECOPL1234UG19	34W	>80	3200lm/4000K	240V	90°	1.2m flex and plug
ECOPL1234EG2	27W	>80	2900lm/4000K	240V	110°	1.2m flex and plug

3. ACCESSORIES (TO BE PURCHASED SEPARATELY):

Product Code	Accessories	Dimension mm Surface Frame/ Base Frame		Suitable for Pierlite ECO LED Panel Gen2
UDFRM/12-3 *Note	Universal Deep Surface Mount Frame	1200x300x70mm 1200x354x70mm		Panel Dimension: 1195 x 295 x 30.3mm ECOPL123CSEG2 ECOPL1234UG19 ECOPL1234EG2
UDFRM/6-3 *Note	Universal Deep Surface Mount Frame Surface frame dimension	600x300x70mm 600x354x70mm		Panel Dimension: 595 x 295 x 30.3mm ECOPL063CSEG2
UDFRM/6-6 *Note	Universal Deep Surface Mount Frame	600x600x70mm 600x654x70mm		Panel Dimension: 595 x 595 x 30.3mm ECOPL066CSEG2
UDFRM/12-6 *Note	Universal Deep Surface Mount Frame	1200x600x70mm 1200x654x70mm		Panel Dimension: 1195 x 595 x 30.3mm ECOPL126CSEG2
ECOPLWIREKITG2 Or ECOPLWIREKITG2H	Panel wire suspension kit Y-shape, 1m (includes 2 brackets)	1 Meter suspension wire and 2 brackets		ECOPL123CSEG2 – need 2 packs ECOPL1234UG19 – need 2 packs ECOPL1234EG2 – need 2 packs ECOPL063CSEG2 – need 2 packs ECOPL066CSEG2 – need 2 packs ECOPL126CSEG2 – need 3 packs
FRM/PM18W	Plaster frame for mounting ECO Panel into plaster ceiling	600x300		Panel Dimension: 595 x 295 x 30.3mm ECOPL063CSEG2
FRM/PM18WIDE	Plaster frame for mounting ECO Panel into plaster ceiling	600x600		Panel Dimension: 595 x 595 x 30.3mm ECOPL066CSEG2
FRM/PM36W	Plaster frame for mounting ECO Panel into plaster ceiling	1200x300		Panel Dimension: 1195 x 295 x 30.3mm ECOPL123CSEG2 ECOPL1234UG19 ECOPL1234EG2
FRM/PM36WIDE	Plaster frame for mounting ECO Panel into plaster ceiling	1200x600		Panel Dimension: 1195 x 595 x 30.3mm ECOPL126CSEG2
ECOPNLBRKTKIT	Angle bracket kits for seismic restraints installation			1 kit includes 4 brackets and 4 screws

*Note: When installation on concrete or inaccessible ceilings, it is recommended to remove the plug and connect a miniature junction box (purchased separately in the market).

4. APPROVALS: The RCM marking of this product applies to AS/NZS CISPR15 (EMC) "Limits and methods of measurement of radio disturbance characteristics of electrical lighting and similar equipment". This product is designed to conform to AS/NZS60598 "Luminaires, general requirements and tests".

5. STORAGE: Prior to installation products are to be stored in cool and dry conditions.

6. APPLICATION: The installation application and orientation of the product is designed in accordance with the nominated product IP rating, class designation and these installation instructions. Installation environments and operating conditions beyond these instructions are not recommended.

7. INSTALLATION / GENERAL: Installation of the product is to be completed by an authorized and licensed electrician, in accordance with these instructions, relevant Australia standards and local regulations (where applicable). Termination of product wiring, together with the installation of the product must be in a manner and orientation that maintains the integrity of the designated IP rating of the product for electronic control equipment (when supplied) **DO NOT MEGGER** between A and N.

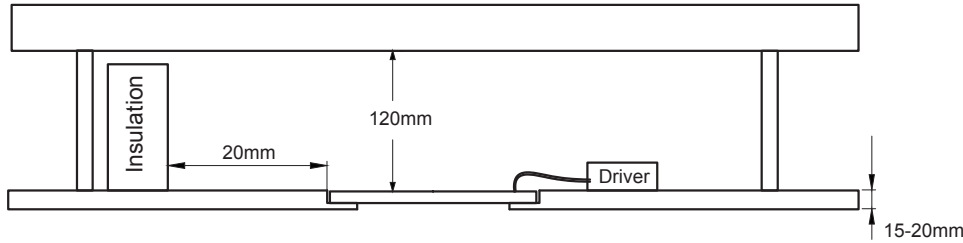

Note: Distance between driver and building element 0mm.

8. INSTALLATION / SPECIAL CONDITIONS (relevant only for products approved for such an installation):

(a) products installed in high wind environments must have suitable installation / fastening methods applied to ensure the product's mounting points are not damaged through, corrosion, constant vibration and or movement. Exterior products are designed with precise vertical aiming limits, which should not be exceeded. Any vertical floodlight aiming requirements should be specifically validated in writing with the relevant brand before consideration.

(b) products installed in corrosive or salt laden environments require special consideration and such; specific product selection, inclusive of suitable fastening methods and extensive ongoing maintenance of products installed in these environments require professional advice. It is essential that all aspects of the product selection, material specification and maintenance are specifically designed for such use and a cleaning program be adopted that maintains the design integrity of the product.

(c) interior highbay products must be vertically suspended. The method of suspension (chain etc.) must be able to support at least 5 times the total weight of the fitting. Do not install where air movement will cause the fitting to swing about, causing wear and tear of attachment points. Luminaires should be installed where access for maintenance is practical and allows for maintenance to be completed in accordance with the manufacturer's recommendations.

(d) interior (downlight) products must be installed to ensure the lamp unit or the driver (if supplied) are not covered with any combustible materials or insulation; minimum spacing's nominated for these materials are mandatory. Unless otherwise specified, minimum clearances are in accordance with AS3000 requirements. The product is not designed for installation environments which restrict conventional airflow movements e.g. : enclosed boxes or concrete profiles. For dimming purposes please see the relevant product brand web site for the dimming compatibility chart. When mounting multiple fixtures to conductive structures, it is recommended that the structure is earthed. The mounting facilities provided for the transformer/driver (if any), need only be utilized if in the application of the product is required by AS3000. IP ratings stated (if any) are from below the ceiling unless stated otherwise and the installation of the product must be in a manner that maintains the integrity of the relevant IP rating.

9. DRAWINGS

ECOPL063CSEG2 – 595 mm x 295 mm x 30.3mm

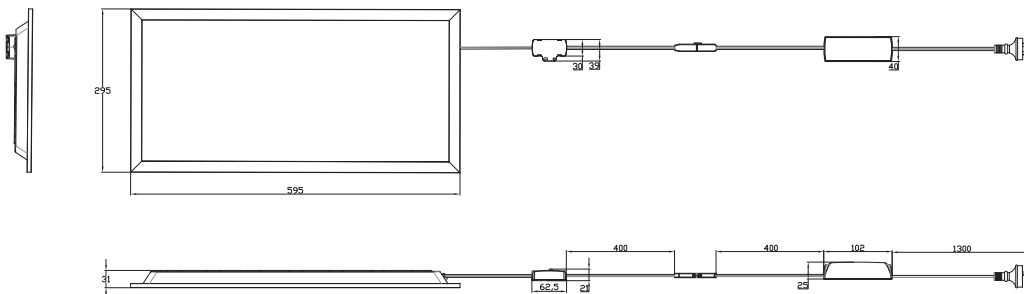

ECOPL066CSEG2 – 595 mm x 595 mm x 30.3mm

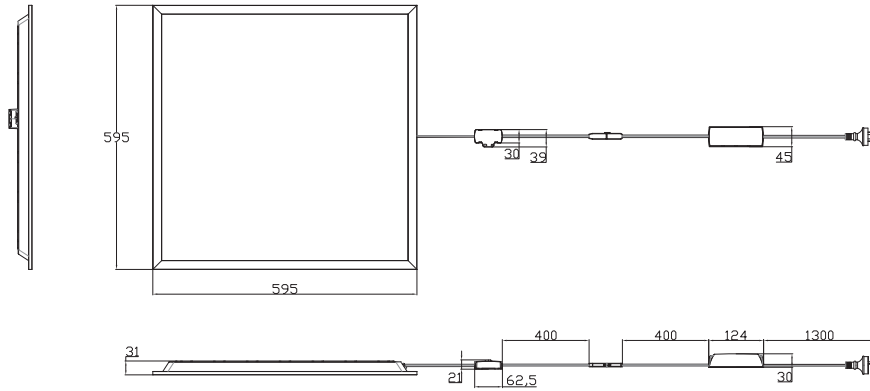

ECOPL123CSEG2/ECOPL1234UG19/ECOPL1234EG2 – 1195 mm x 295 mm x 30.3mm

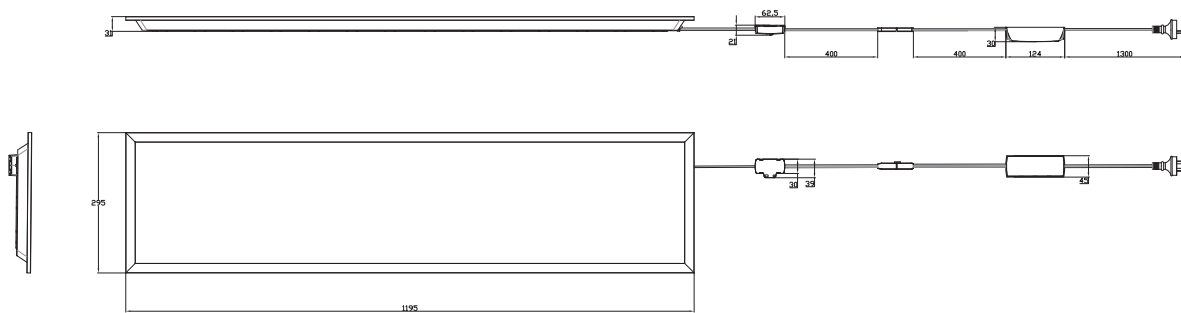

ECOP126CSEG2 – 1195 mm x 595 mm x 30.3mm

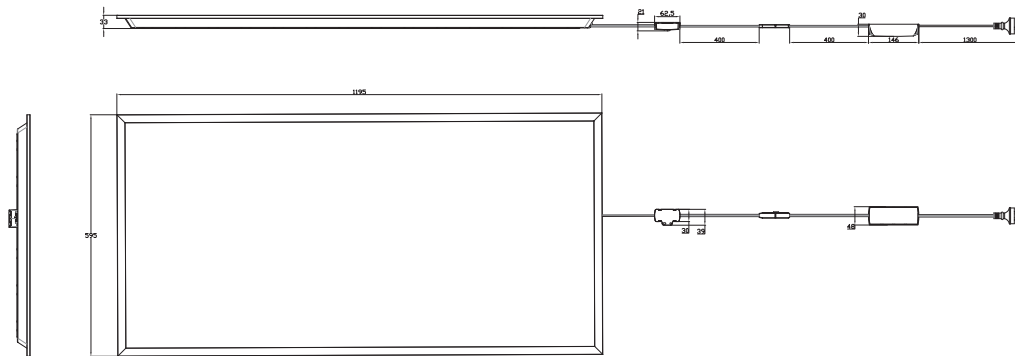

10. UNIVERSAL DEEP SURFACE MOUNT FRAME (Product Code: UDFRM/12-3, UDFRM/6-3, UDFRM/6-6 to be purchased separately)

Universal deep surface mount frame is designed for applications:

- Where all components (including driver, flex & plug) are required to fit inside the frame i.e. ideal for concrete ceilings
- With limited room around the frame i.e. panel is required to be dropped in (rather than slid in)
- When installation on concrete or inaccessible ceilings, it is recommended to remove the plug and connect a miniature junction box (purchased separately in the market).

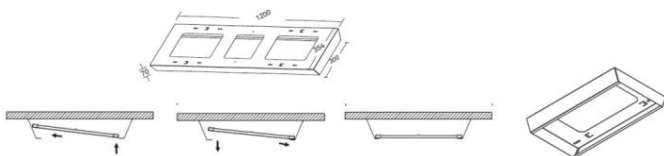

11. PLASTER MASTER FRAME (Product Code: FRM/PM18W, FRM/PM18WIDE, FRM/PM36W, FRM/PM36WIDE to be purchased separately)

Plaster master frame is designed for mounting panel into set plasterboard ceiling.

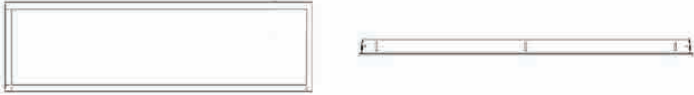

12. SUSPENSION KIT (Product Code ECOPLWIREKITG2 or ECOPLWIREKITG2H)

Suspension kit is designed for applications:

Where it is not possible or desirable to surface mount or recessed the panel.

Suspension kit is available for standalone panels and surface frames. Check above the quantity of suspension kit needed for the panel.

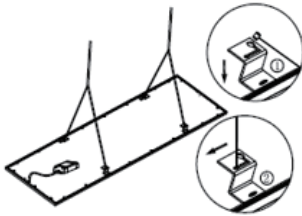

ECOPLWIREKITG2

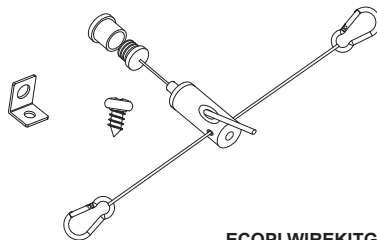

ECOPLWIREKITG2H

13. MAINTENANCE:

(a) The supply must be isolated before opening or accessing the luminaire. Product maintenance is IMPORTANT and is critical to the products designed performance. The product is to be maintained in accordance with the manufacturer's instructions. For the latest product maintenance guides please go to relevant brand web site. Gerard Lighting is not responsible for any product not maintained in accordance with the recommended procedure or intervals. **(b) lamps (where provided):** The product is designed with the supplied (LEDs) / LAMP/s and it is strongly recommended that any LAMP / (LEDs) changes (if any) be made in accordance with the type, colour and brand supplied. For recommended LAMP / LED maintenance or operating guides (inclusive of recommended product switch cycles and mandatory run-in procedures for HID and Fluorescent lamps when used with dimming circuits), Gerard Lighting recommends the application of the lamp manufacturer's operating guidelines, which can be found on manufacturer's website. Gerard Lighting is not responsible for the product performance of alternative lamp/s used. As a member of FluroCycle, we encourage recycling of lamps and components. **(c) battery (where provided):** The battery is designed with a rated average battery design life of 25,000 hours in standby mode. The battery is supported with a standard 3-year warranty; conditional of the product being maintained and operated in accordance with the manufacturer's guidelines and tested in accordance with AS/NZS2293. For guidelines see product installation instructions or visit the relevant brand web site. **(d) for products supplied with glass visors or covers**, do not operate the product with a damaged visor or cover; it is recommended the product be turned off, area surrounding the product vacated and the damaged glass replaced by a professional installer immediately.

14. WARRANTY INSTRUCTIONS: For the purpose of warranty claims (if any) the following instructions apply:











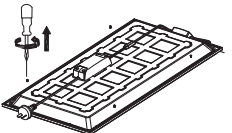

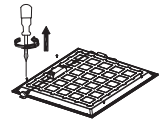

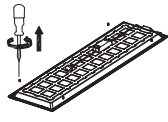

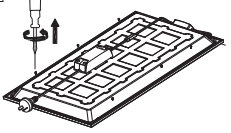
Warranty components – THE PRODUCT, (identified as the PRODUCT only). **Warranty period** – The above components are provided with a warranty of **three (3) year/s or 15,000 hours of operations (which ever arrive first)** against manufacturing defects or failure to perform to specifications for products installed by an authorised installer in accordance with the manufacturer's installation instructions and which have not been subject to incorrect operation or maintenance, unauthorised modification or damage arising from any intervening cause. **Warranty reference** – The warranty reference date commences from the date of purchase. **Warranty point of contact** – Gerard Lighting Pty Ltd, 96 Gow Street Padstow NSW 2211, phone T 02 9794 9300 contact – Gerard Lighting After Sales Support.

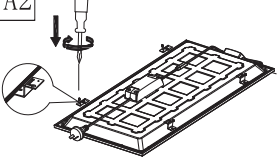
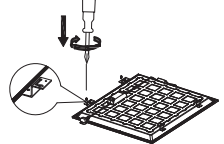
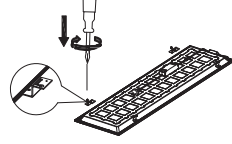
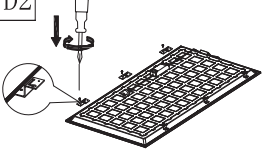
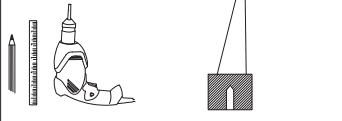
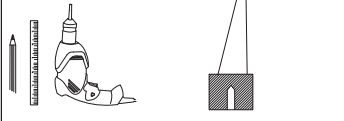
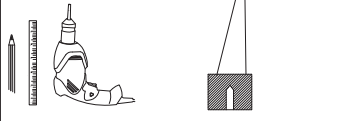
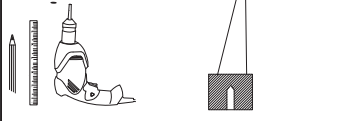
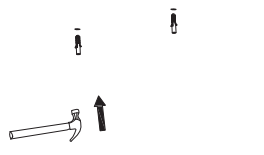
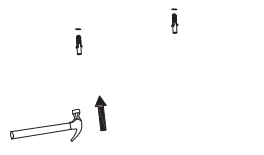
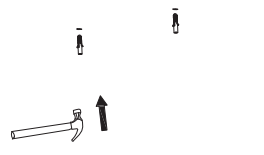
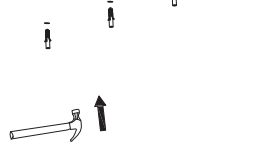
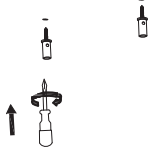
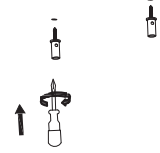
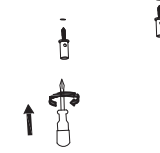
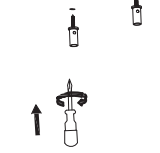
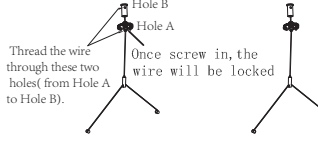
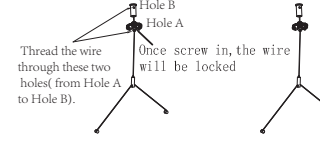
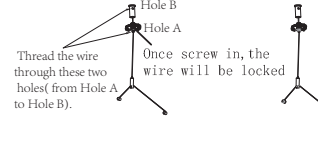
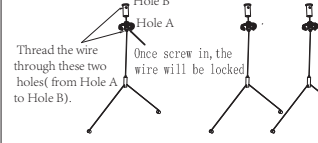
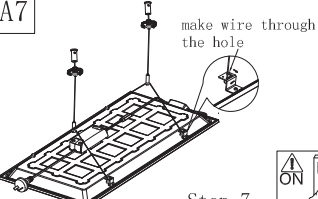
Warranty claim procedure – For the purpose of making a claim the customer must:

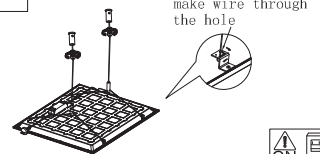

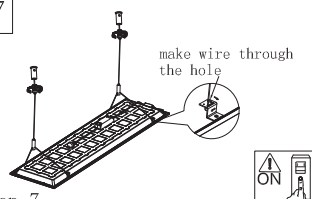

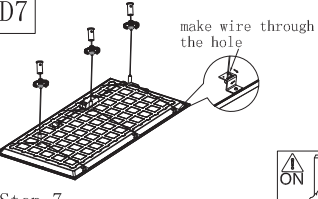
1. Contact the "point of contact" above and upon provision of proof of purchase the customer will receive a goods return advice (GRA) number.
 2. At the customer's expense, collect and return the goods to the "point of contact" with the issued GRA number.
 3. Upon receipt of the goods, Gerard Lighting will review the claim and if found to be accepted, Gerard Lighting will return a replacement product to the customer to install at the customer's expense. Alternatively if the claim is rejected, the customer may request the return of the goods at their expense. **Consumer Contracts** - The benefits to the customer given by the Gerard Lighting warranty are in addition to other rights and remedies of the customer if the goods are the subject of a Consumer Contract under the Australian Consumer Law. In that event the following statement is required to be brought to the Consumer's attention: - *Our goods come with guarantees that cannot be excluded under the Australian Consumer Law. You are entitled to a replacement or refund for a major failure and for compensation for any other reasonably foreseeable loss or damage. You are also entitled to have the goods repaired or replaced if the goods fail to be of acceptable quality and the failure does not amount to a major failure.*

Limitation of Liability – if the goods are not purchased by the customer under a Consumer Contract within the Australian Consumer Law then but not otherwise; - (a) the Company is not liable in tort for any loss or damage suffered by the customer or by any third party; and (b) in no circumstances is Gerard Lighting liable to the customer or to any third party for any loss of profits, loss of anticipated savings, economic loss or interruption of business or for any indirect or consequential loss (Consequential Loss). **Terms of Sale** – these Warranty provisions are in substitution for any inconsistent provisions in the Gerard Lighting Terms and Conditions of Sale in so far as they apply to the Warranty components.

15. Suspension Kit – there are Wire Type (ECOPLWIREKITG2) and Mountain hook Type (ECOPLWIREKITG2H)

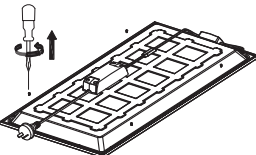
ECOPL063CSEG2 suspension kits installation instruction	ECOPL066CSEG2 suspension kits installation instruction	ECOPL123CSEG2/ECOPL1234EG2 /ECOPL1234UG19 suspension kits installation instruction	ECOPL126CSEG2 suspension kits installation instruction
<p>A1</p>  <p>Remove the second and seventh screws on both long sides</p> <p>Step 1</p> 	<p>B1</p>  <p>Remove the second and seventh screws from any parallel directions</p> <p>Step 1</p> 	<p>C1</p>  <p>Remove the second and thirteenth screws on both long sides</p> <p>Step 1</p> 	<p>D1</p>  <p>Remove the second, seventh and thirteenth screws on both long sides</p> <p>Step 1</p> 
<p>A2</p>  <p>Step 2</p>	<p>B2</p>  <p>Step 2</p>	<p>C2</p>  <p>Step 2</p>	<p>D2</p>  <p>Step 2</p>
<p>A3</p>  <p>Pre drill hole for insert expansion screw, for the suspension kit</p> <p>Step 3</p>	<p>B3</p>  <p>Pre drill hole for insert expansion screw, for the suspension kit</p> <p>Step 3</p>	<p>C3</p>  <p>Pre drill hole for insert expansion screw, for the suspension kit</p> <p>Step 3</p>	<p>D3</p>  <p>Pre drill hole for insert expansion screw, for the suspension kit</p> <p>Step 3</p>
<p>A4</p>  <p>Step 4</p>	<p>B4</p>  <p>Step 4</p>	<p>C4</p>  <p>Step 4</p>	<p>D4</p>  <p>Step 4</p>
<p>A5</p>  <p>Step 5</p>	<p>B5</p>  <p>Step 5</p>	<p>C5</p>  <p>Step 5</p>	<p>D5</p>  <p>Step 5</p>
<p>A6</p>  <p>Thread the wire through these two holes (from Hole A to Hole B). Once screw in, the wire will be locked</p> <p>Step 6</p>	<p>B6</p>  <p>Thread the wire through these two holes (from Hole A to Hole B). Once screw in, the wire will be locked</p> <p>Step 6</p>	<p>C6</p>  <p>Thread the wire through these two holes (from Hole A to Hole B). Once screw in, the wire will be locked</p> <p>Step 6</p>	<p>D6</p>  <p>Thread the wire through these two holes (from Hole A to Hole B). Once screw in, the wire will be locked</p> <p>Step 6</p>
<p>A7</p>  <p>make wire through the hole</p> <p>Step 7</p> 	<p>B7</p>  <p>make wire through the hole</p> <p>Step 7</p> 	<p>C7</p>  <p>make wire through the hole</p> <p>Step 7</p> 	<p>D7</p>  <p>make wire through the hole</p> <p>Step 7</p> 

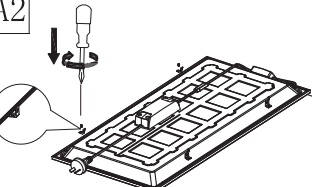
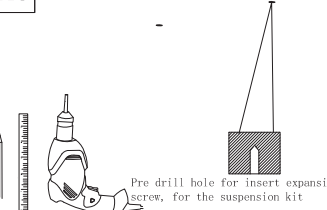
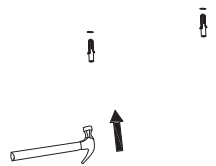
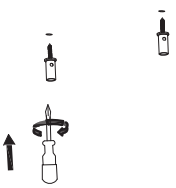
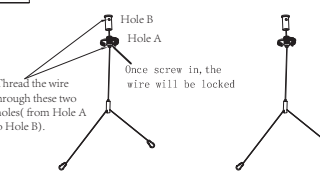
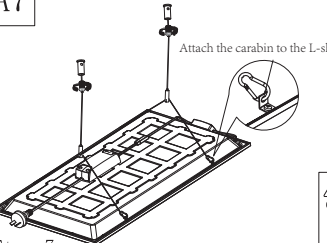
16. Suspension Kit – Mountain hook type (ECOPLWIREKITG2H)

<p>A1</p>  <p>Remove the second and seventh screws on both long sides</p> <p>Step 1</p> 	<p>A2</p>  <p>Step 2</p>	<p>A3</p>  <p>Pre drill hole for insert expansion screw, for the suspension kit</p> <p>Step 3</p>	<p>A4</p>  <p>Step 4</p>
<p>A5</p>  <p>Step 5</p>	<p>A6</p>  <p>Hole B Hole A</p> <p>Thread the wire through these two holes from Hole A to Hole B.</p> <p>Once screw in, the wire will be locked</p> <p>Step 6</p>	<p>A7</p>  <p>Attach the carabin to the L-shaped bracket</p> <p>Step 7</p> 	

L-shaped bracket got one big hole and one small hole

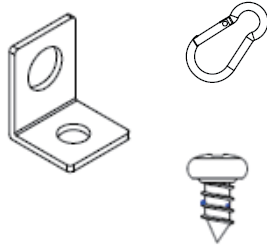





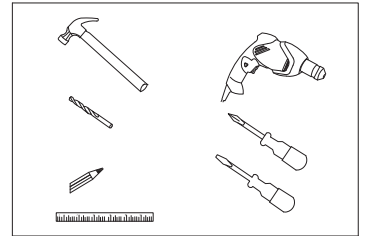



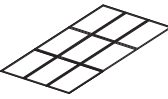

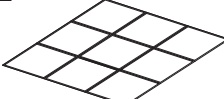

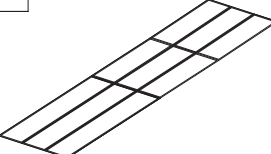

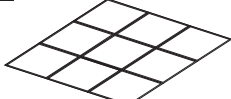



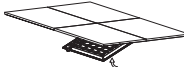



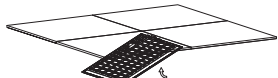

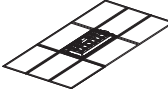
Connect the hook to the BIG hole of L-shaped bracket

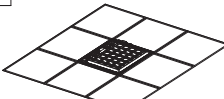
tighten the screw on panel through the SMALL hole of L-shaped bracket

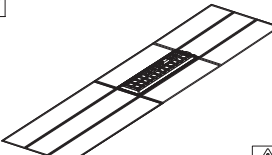

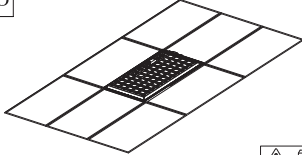
RECESSED INSTALLATION

ECOPL063CSEG2 recessed installation instruction	ECOPL066CSEG2 recessed installation instruction	ECOPL123CSEG2/ECOPL1234EG2 /ECOPL1234UG19 recessed installation instruction	ECOPL126CSEG2 recessed installation instruction
<p>A1</p>  <p>Step 1</p> 	<p>B1</p>  <p>Step 1</p> 	<p>C1</p>  <p>Step 1</p> 	<p>D1</p>  <p>Step 1</p> 
<p>A2</p>  <p>Step 2</p> 	<p>B2</p>  <p>Step 2</p> 	<p>C2</p>  <p>Step 2</p> 	<p>D2</p>  <p>Step 2</p> 
<p>A3</p>  <p>Step 3</p> 	<p>B3</p>  <p>Step 3</p> 	<p>C3</p>  <p>Step 3</p> 	<p>D3</p>  <p>Step 3</p> 

17. Seismic Restraints installation with product code: ECOPNLBRKTKIT (1 kit includes 4 Angle Brackets and screws)

Includes:



Angle Bracket
x 4



Angle Bracket Fixing Screw
x 4

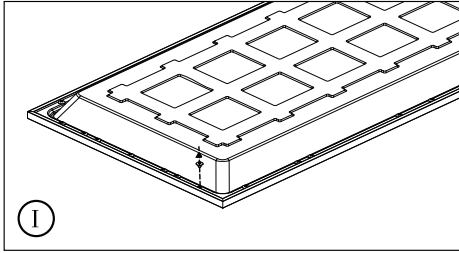

Remove original screw from the corner on the rear of the LED Panel.

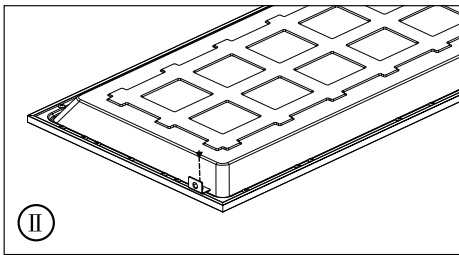

Use enclosed Angle Bracket Fixing Screw to fix an Angle Bracket at the corner. Angle bracket should be placed against the edge of the LED Panel. Repeat this step at the other corners.

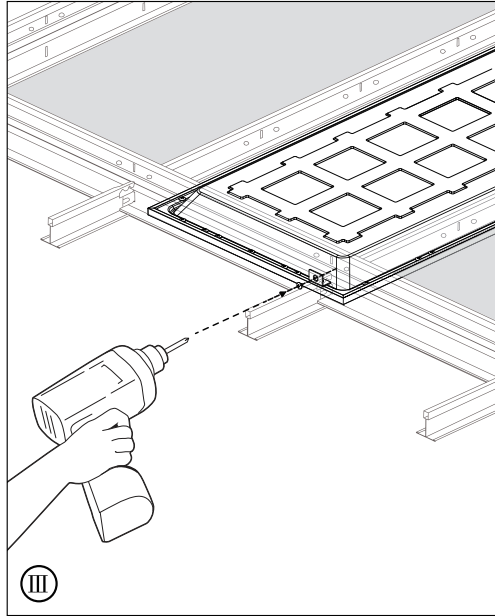

Fix angle bracket to T-rail through a convenient hole with a screw (max. length 16mm) from either side. Repeat this step at the other corners.

18. For DALI, 1-10V and Phase dim, please refer to the below configurations.

* Original driver should be removed before connection.

Pierlite ECO LED Panel Gen2	Operating Current	DALI Dimming GLG Driver Product Code	Wattage total
ECOPL063CSEG2	350mA	DAD20D03501	14W
ECOPL066CSEG2	700mA	DAD32D07001	27W
ECOPL123CSEG2	700mA	DAD32D07001	27W
ECOPL1234EG2	700mA	DAD32D07001	27W
ECOPL1234UG19	850mA	DAD50D08501	34W
ECOPL126CSEG2	1250mA	DAT60D12501	50W
Pierlite ECO LED Panel Gen2	Operating Current	1-10V Dimming GLG Driver Product Code	Wattage total
ECOPL063CSEG2	350mA	DAD32V03501	14W
ECOPL066CSEG2	700mA	DAD32V07001	27W
ECOPL123CSEG2	700mA	DAD32V07001	27W
ECOPL1234EG2	700mA	DAD32V07001	27W
ECOPL1234UG19	850mA	DAD50V08501	34W
Pierlite ECO LED Panel Gen2	Operating Current	Phase Dimming GLG Driver Product Code	Wattage total
ECOPL063CSEG2	350mA	DAD32PH03501	14W
ECOPL066CSEG2	700mA	DAD32PH07001	27W
ECOPL123CSEG2	700mA	DAD32PH07001	27W
ECOPL1234EG2	700mA	DAD32PH07001	27W
ECOPL1234UG19	850mA	NA	34W