

**INSTALLATION / WARRANTY INSTRUCTIONS**

issue date: 30/09/2019

**PRODUCT BRAND** Pierlite ECO LED Batten Gen 3

**PRODUCT NAME / CODES** ECOBAT202ECSG3, ECOBAT404ECSLS

**PLEASE READ THESE INSTALLATION INSTRUCTIONS CAREFULLY BEFORE INSTALLING OR MAINTAINING THIS EQUIPMENT. THE PRODUCT IS DESIGNED FOR INSTALLATION AND MAINTENANCE IN ACCORDANCE WITH RELEVANT AUSTRALIAN STANDARDS (AS3000) AND LOCAL REGULATIONS (WHERE APPLICABLE), BY AN AUTHORISED AND LICENCED ELECTRICIAN.** THE INSTALLATION INSTRUCTIONS WERE CORRECT AT THE TIME OF PRINT. TO REFLECT CHANGES IN TECHNOLOGY AND AUSTRALIAN STANDARDS; GERARD LIGHTING RESERVES THE RIGHT TO AMEND THE INSTRUCTIONS WITHOUT NOTICE. UPDATED GUIDELINES CAN BE FOUND ON THE RELEVANT BRAND WEB SITE. **IMPORTANT** - THE PRODUCT MUST BE MAINTAINED AND OPERATED IN ACCORDANCE WITH THE MANUFACTURER'S INSTRUCTIONS, FAILURE TO DO SO MAY DAMAGE THE PRODUCT AND SERVICES. IT IS STRONGLY RECOMMENDED THAT THIS IMPORTANT NOTE BE COMMUNICATED TO THE OWNER AND OR OPERATOR OF THE INSTALLATION AT THE TIME OF SITE COMMISSIONING. GOOD PRACTICE DOES NOT RECOMMEND THE 24/7 USE OF PRODUCTS WITHOUT THE APPLICATION OF SUITABLE SWITCH CYCLE INTERVALS. FURTHERMORE, WITH THE OMISSION OF NOMINATED SURVIVAL CURVES AND OR RECOMMENDED OPERATING HOURS, PRODUCT DESIGN EXPECTATIONS PROVIDE FOR A CONTINUAL DAILY USAGE OF 6 HOURS FOR RESIDENTIAL APPLICATIONS AND A CONTINUAL DAILY USAGE OF 12 HOURS FOR COMMERCIAL AND INDUSTRIAL APPLICATIONS. ALL PRODUCTS MUST BE THOROUGHLY CLEANED ON A REGULAR BASIS AT INTERVALS THAT REFLECT IN THE INSTALLATION ENVIRONMENT, ENSURING THE OPTICAL PERFORMANCE, TOGETHER WITH THE ELECTRICAL, MECHANICAL AND STRUCTURAL INTEGRITY AS DESIGNED, IS MAINTAINED THROUGHOUT THE SERVICE LIFE OF THE PRODUCT.



**1. PRODUCT SPECIFICATION :**

	ECOBAT202ECSG3	ECOBAT404ECSLS			
Type of Protection	Class I				
Body Material	Steel body with Opal Polycarbonate diffuser				
Finish	Powder coated				
Circuit Wattage	18W	36W	30W	25W	18W
Nominal Voltage	220-240V				
Line Current	0.07A	0.15A	0.14A	0.12A	0.09A
Nominal Freq. (Hz)	50Hz				
Power factor	>0.90				
Inrush current	<12A/350us	<20A/350us			
Leakage current	0.75mA	0.35mA			
Rated operating ambient temperature	40 degree Celsius				
LED lifetime (L80 B50) @ 25 °C	54,000 hours				
Lumen output (lm)	4000K (1700lm), 5000K (1900lm), 6500K (1700lm)		please refer to next page		
IP Rating	IP20 for interior use only				
Suitable for direct mounting on flammable surfaces	No				
Dimmable	No				
Installation orientation	Surface mounted				
Installation type	Fixed				
Designed application	Interior commercial (Interior)				
Electrical connection	hard wired				
Dimensions	74mm x 74 mm x 603mm		74mm x 74mm x 1164mm		
Net Weight of luminaire	0.8 kg		1.51 kg		

ECOBAT404ECSLS is a colour select and power select batten. Factory settings could be altered accordingly by adjusting the DIP switches on the driver.

Power select dip switches are located on the driver

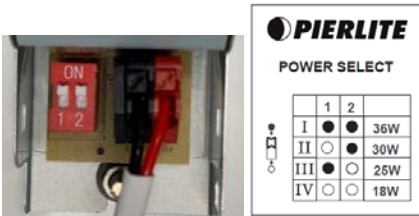

System Wattage (W)	Line Current (A)	Driver settings (mA)	4000K (lm)	5000K (lm)	6500K (lm)
36W	0.15	350	3600	4100	3700
30W	0.14	300	3200	3600	3300
25W	0.12	250	2700	2960	2770
18W	0.09	200	2180	2300	2190

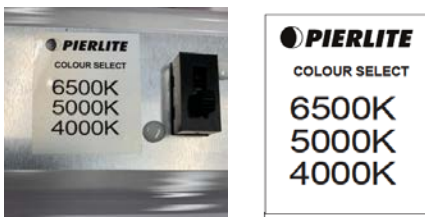

- APPROVALS:** The RCM marking of this product applies to AS/NZS CISPR15 (EMC) "Limits and methods of measurement of radio disturbance characteristics of electrical lighting and similar equipment". This product is designed to conform to AS/NZS60598 "Luminaires, general requirements and tests".
- STORAGE:** Prior to installation products are to be stored in cool and dry conditions.
- APPLICATION:** The installation application and orientation of the product is designed in accordance with the nominated product IP rating, class designation and these installation instructions. Installation environments and operating conditions beyond these instructions are not recommended.
- INSTALLATION / GENERAL:** Installation of the product is to be completed by an authorized and licensed electrician, in accordance with these instructions, relevant Australia standards and local regulations (where applicable). Termination of product wiring, together with the installation of the product must be in a manner and orientation that maintains the integrity of the designated IP rating of the product For electronic control equipment (when supplied) DO NOT MEGGER between A and N.
- INSTALLATION / SPECIAL CONDITIONS** (relevant only for products approved for such an installation):

- products installed in high wind environments** must have suitable installation / fastening methods applied to ensure the product's mounting points are not damaged through, corrosion, constant vibration and or movement. Exterior products are designed with precise vertical aiming limits, which should not be exceeded. Any vertical floodlight aiming requirements should be specifically validated in writing with the relevant brand before consideration.
- products installed in corrosive or salt laden environments** require special consideration and such; specific product selection, inclusive of suitable fastening methods and extensive ongoing maintenance of products installed in these environments require professional advice. It is essential that all aspects of the product selection, material specification and maintenance are specifically designed for such use and a cleaning program be adopted that maintains the design integrity of the product.
- interior highbay products** must be vertically suspended. The method of suspension (chain etc) must be able to support at least 5 times the total weight of the fitting. Do not install where air movement will cause the fitting to swing about,

causing wear and tear of attachment points. Luminaires should be installed where access for maintenance is practical and allows for maintenance to be completed in accordance with the manufacturer's recommendations.

**(d) interior (downlight) products** must be installed to ensure the lamp unit or the driver (if supplied) are not covered with any combustible materials or insulation; minimum spacings nominated for these materials are mandatory. Unless otherwise specified, minimum clearances are in accordance with AS3000 requirements. The product is not designed for installation environments which restrict conventional airflow movements eg: enclosed boxes or concrete profiles. For dimming purposes please see the relevant product brand web site for the dimming compatibility chart. When mounting multiple fixtures to conductive structures, it is recommended that the structure is earthed. The mounting facilities provided for the transformer/driver (if any), need only be utilized if in the application of the product is required by AS3000. IP ratings stated (if any) are from below the ceiling unless stated otherwise and the installation of the product must be in a manner that maintains the integrity of the relevant IP rating.

## 7. MAINTENANCE:

**(a)** The supply must be isolated before opening or accessing the luminaire. Product maintenance is IMPORTANT and is critical to the products designed performance. The product is to be maintained in accordance with the manufacturer's instructions. For the latest product maintenance guides please go to relevant brand web site. Gerard Lighting is not responsible for any product not maintained in accordance with the recommended procedure or intervals. **(b) lamps (where provided):** The product is designed with the supplied (LEDs) / LAMP/s and it is strongly recommended that any LAMP / (LEDs) changes (if any) be made in accordance with the type, colour and brand supplied. For recommended LAMP / LED maintenance or operating guides (inclusive of recommended product switch cycles and mandatory run-in procedures for HID and Fluorescent lamps when used with dimming circuits), Gerard Lighting recommends the application of the lamp manufacturer's operating guidelines, which can be found on manufacturer's website. Gerard Lighting is not responsible for the product performance of alternative lamp/s used. As a member of FluroCycle, we encourage recycling of lamps and components. **(c) battery (where provided):** The battery is designed with a rated average battery design life of 25,000 hours in standby mode. The battery is supported with a standard 12-month warranty; conditional of the product being maintained and operated in accordance with the manufacturer's guidelines and tested in accordance with AS/NZS2293. For guidelines see product installation instructions or visit the relevant brand web site. **(d) for products supplied with glass visors or covers**, do not operate the product with a damaged visor or cover; it is recommended the product be turned off, area surrounding the product vacated and the damaged glass replaced by a professional installer immediately.

**8. WARRANTY INSTRUCTIONS:** For the purpose of warranty claims (if any) the following instructions apply:

**Warranty components** – THE PRODUCT, (identified as the THE PRODUCT only). **Warranty period** - The above components are provided with a warranty of FOUR (4) years or 20,000 hours against manufacturing defects or failure to perform to specifications for products installed by an authorised installer in accordance with the manufacturer's installation instructions and which have not been subject to incorrect operation or maintenance, unauthorised modification or damage arising from any intervening cause. **Warranty reference** - The warranty reference date commences from the date of purchase. **Warranty point of contact** – Gerard Lighting Pty Ltd, 96 Gow Street Padstow NSW 2211, phone T 02 9794 9300 contact – Gerard Lighting After Sales Support.

**Warranty claim procedure** – For the purpose of making a claim the customer must:

1. Contact the "point of contact" above and upon provision of proof of purchase the customer will receive a goods return advice (GRA) number.
2. At the customer's expense, collect and return the goods to the "point of contact" with the issued GRA number.
3. Upon receipt of the goods, Gerard Lighting will review the claim and if found to be accepted, Gerard Lighting will return a replacement product to the customer to install at the customer's expense. Alternatively, if the claim is rejected, the customer may request the return of the goods at their expense.

**Consumer Contracts** - The benefits to the customer given by the Gerard Lighting warranty are in addition to other rights and remedies of the customer if the goods are the subject of a Consumer Contract under the Australian Consumer Law. In that event the following statement is required to be brought to the Consumer's attention: - *Our goods come with guarantees that cannot be excluded under the Australian Consumer Law. You are entitled to a replacement or refund for a major failure and for compensation for any other reasonably foreseeable loss or damage. You are also entitled to have the goods repaired or replaced if the goods fail to be of acceptable quality and the failure does not amount to a major failure.* **Limitation of Liability** – if the goods are not purchased by the customer under a Consumer Contract within the Australian Consumer Law then but not otherwise; - (a) the Company is not liable in tort for any loss or damage suffered by the customer or by any third party; and (b) in no circumstances is Gerard Lighting liable to the customer or to any third party for any loss of profits, loss of anticipated savings, economic loss or interruption of business or for any indirect or consequential loss (Consequential Loss). **Terms of Sale** – these Warranty provisions are in substitution for any inconsistent provisions in the Gerard Lighting Terms and Conditions of Sale in so far as they apply to the Warranty components.

Line Drawings

ECOBAT202ECSG3

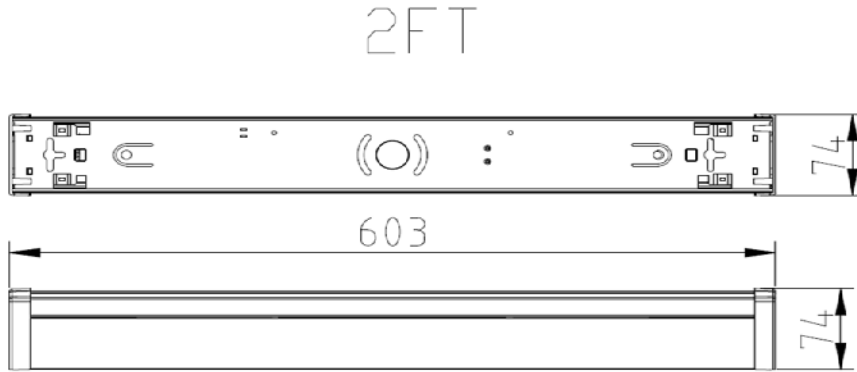

ECOBAT404ECSLS

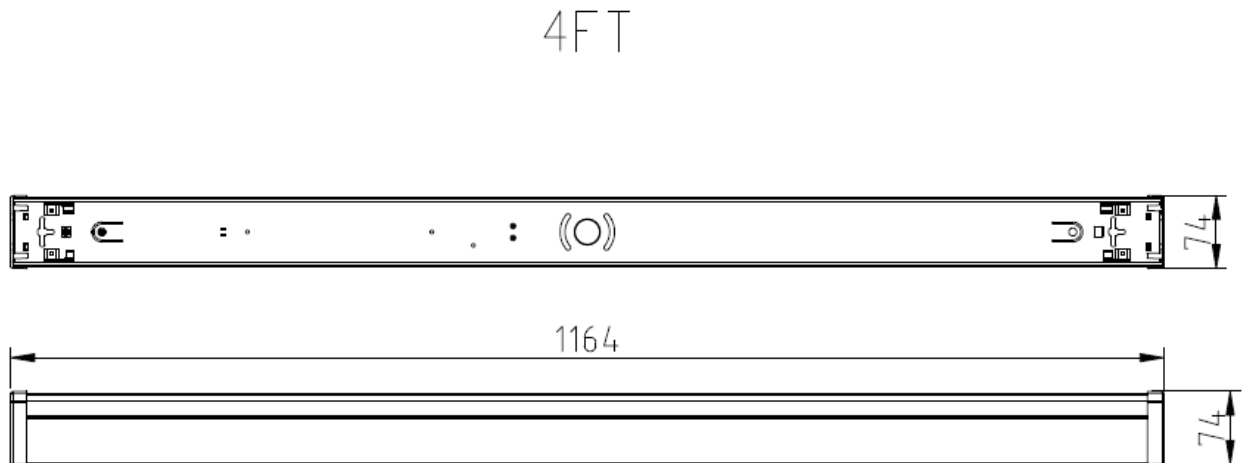

**BATTEN LIGHT INSTRUCTION**

1. Open 2 end caps by using flat screwdriver.

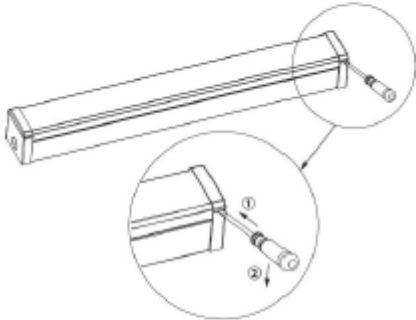

2. Un-tighten Philips screw in one end.

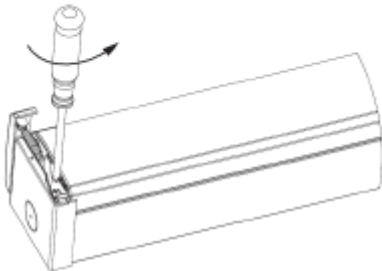

3. Use flat screwdriver to release LED module.



4. Take out LED module & disconnect LED module power cable.

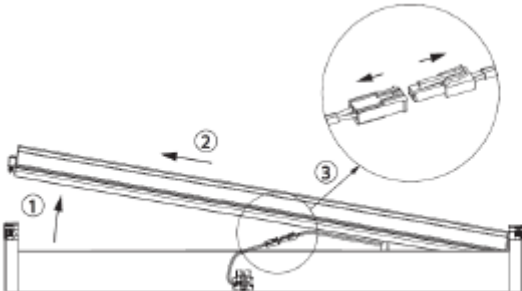

5. Connect wires.

6. Re-connect LED module power cable, ensure arrow symbols are in same direction. Slide the metal tongue into the slot.

7. Push the other end of LED module to the metal housing until hearing click sound.



8. Tighten philips screw.

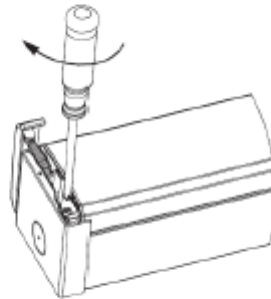

9. Close the end cap.

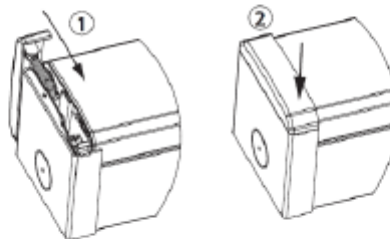

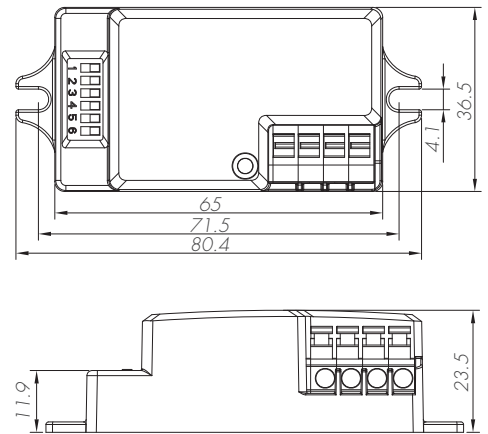
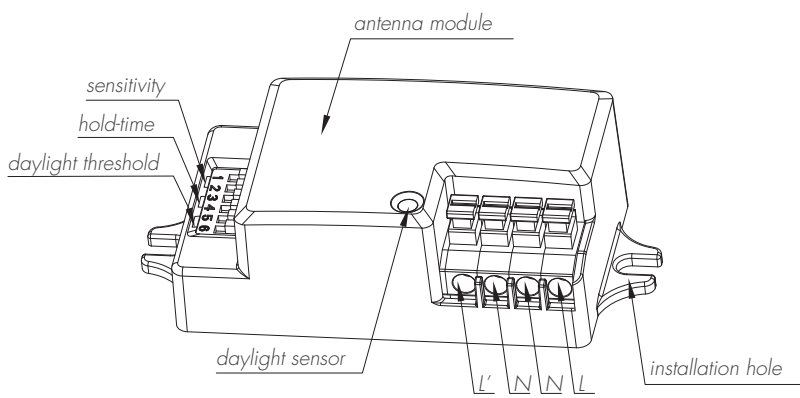

## Sensor Feature

### On/off function

The motion detector can turn on the light based on movement. With this detector built in, light is automatically on when needed and off when not.

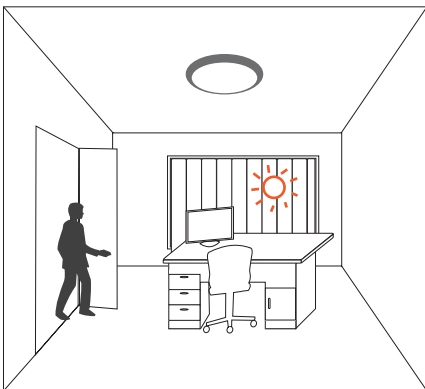

The light keeps off during daytime even when movement is detected. (Ambient lux level is above preset daylight threshold)



With movement and insufficient ambient lux level, the light is triggered on by the detector.

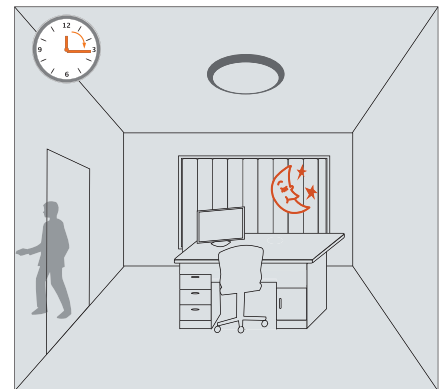

If there is no more movement, the light turns off automatically after hold-time preset.

## Sensor Wiring

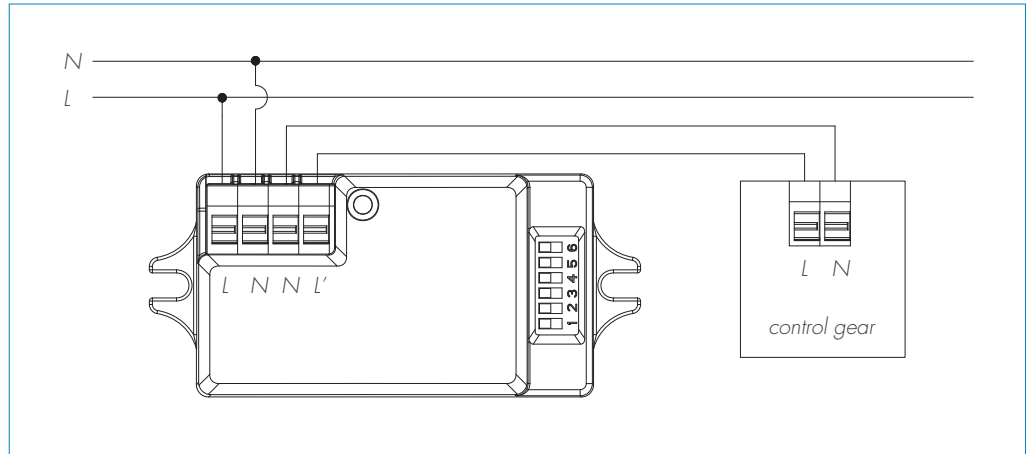

## Detection pattern

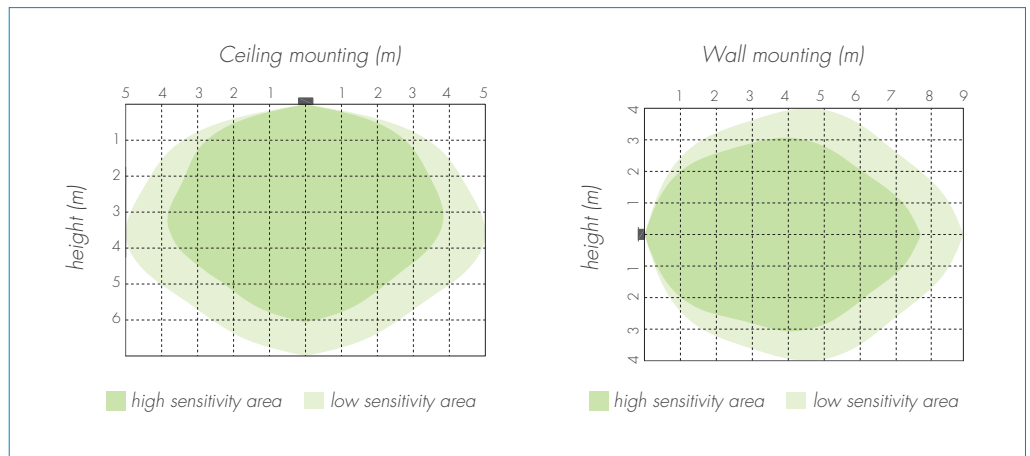

## Settings

### 1. Sensitivity

Sensitivity can be adjusted by selecting the combination on the DIP switches for different applications.

- I – 100%
- II – 75%
- III – 50%
- IV – 10%

	1	2	
I	●	●	100%
II	●	○	75%
III	○	●	50%
IV	○	○	10%

### 2. Hold-time

Hold-time refers to the time period that the light remains 100% on if no more movement is detected.

- I – 5s
- II – 90s
- III – 5min
- IV – 15min

	3	4	
I	●	●	5s
II	●	○	90s
III	○	●	5min
IV	○	○	15min

### 3. Daylight sensor

Different daylight threshold can be preset on DIP switches. Light will always turn on upon movement if daylight sensor is disabled.

- I – Disable
- II – 50Lux
- III – 10Lux
- IV – 2Lux

	5	6	
I	●	●	Disable
II	●	○	50Lux
III	○	●	10Lux
IV	○	○	2Lux

## Sensor Specification

Operating voltage	220 ~ 240 VAC 50/60Hz
Rated load	400W (Capacitive load) 800W (Resistive load)
Stand-by power	<0.5W
Sensitivity	10% / 50% / 75% / 100%
Hold-time	5s / 90s / 5min / 15min
Daylight sensor	2lux / 10lux / 50lux, disable
Microwave frequency	5.8 GHz +/- 75MHz
Transmitting power	<0.2mW
Detection range	maximum (diameter x height): 10m x 6m
Detection angle	30° ~ 150°
Mounting height	maximum 6m
Working temperature	-20°C ~ 60°C
IP rating	IP20