

One Channel and Two Channel DALI Relay Device



REGISTERED DESIGN



Designed in Australia to meet Australian Standards and installation conditions



1. Product Item

This guide provides installation and product specification information for the Diginet One Channel and Two Channel DALI Relay Device, Diginet item numbers

DGOZ-RLY-10A-01 – One Channel Relay Device

DGOZ-RLY-10A-02 – Two Channel Relay Device

2. Important notes and safety information



Electric shock may result in serious injury or death. Follow all warnings in this guide and on the product while working in accordance with the latest electrical safety practices.

Connecting a Diginet DALI Relay Device to mains and/or a DALI Line must be carried out by a suitably qualified installer who must work in accordance with standard safety procedures for mains-powered electrical equipment.

There are no user serviceable parts inside this product. Do not attempt to disassemble or operate the device with any covers removed.

If you require information or assistance regarding the installation or operation of this product, contact Technical Services at Diginet Control Systems. Contact details are provided on the back cover of this guide and also at www.diginet.net.au

3. Product summary

The Diginet one channel and two channel DALI Relay Devices are designed for switching (ON/OFF) up to 10 Amps of load (per channel for the two channel version) via DALI commands issued on a connected DALI line.

The on-board 240Vac rated relay(s) are capable of switching a full 10A of LED, fluorescent, incandescent and HID lighting loads, suitable for a wide range of commercial and industrial building applications.

The devices includes a large area for terminating all 1.5mm² or 2.5mm² double insulated cables (240Vac supply cables, switched load cables and DALI Line cables).

The device is fully tested to and complies with DALI standards IEC 62386.

4. Product Features

- General purpose load switching (ON and OFF) via received DALI commands
- Capable of switching 10AX @ 240Vac
- Includes Neutral and Earth termination bars
- Suitable for mounting in a ceiling void
- Optional DIN rail mounting bracket for mounting the device on standard DIN rail
- LED indicators (DALI and power)
- Each relay channel can be linked to a DALI short address
- Each relay channel is able to be allocated up to 16 DALI Group Addresses and/or up to 16 DALI Scenes
- Short Address, Group Addresses and DALI scenes configured via Diginet RAPIX Addressing software, or any other DALI commissioning software package which supports DALI compliant devices.

5. Mounting the Relay Device

Surface mounting the DALI Relay Device

Three off, 6mm mounting holes are provided for mounting the device.



DGOZ-RLY-10A-02

DIN rail mounting the DALI Relay Device

The device can alternatively be mounted on standard DIN rail using an optional DIN Rail mounting bracket (purchased serpartely, Item Number DGOZ-RLY-DINBKT), as shown below



1. Mount the optional mounting bracket onto DIN rail at the required location.



3. Locate the relay device onto the two pins at the bottom mounting bracket



4. Push the top on the relay device onto the mounting bracket and clip into place

2. Lock into place by pushing up the black locking pin at the bottom of the bracket

6. Connecting the device to a DALI Line

To operate correctly, the DALI Relay Device must be connected to both 240Vac mains power and a DALI Line powered by a DALI Power Supply. The DALI Power supply must be a device which has been designed to and meets the DALI standards. The Diginet DALI Power Supply, Item Number **DGLMPS01** (available separately), can be used.

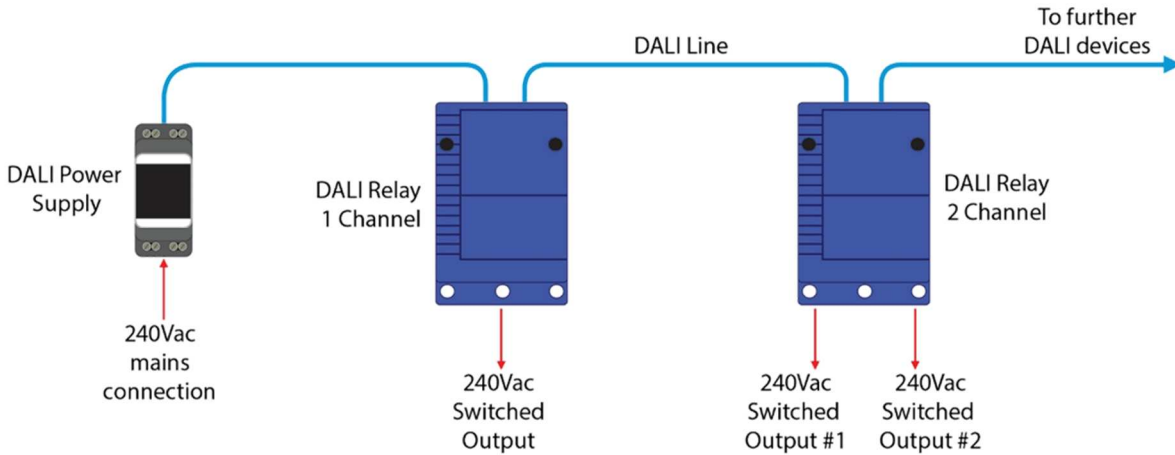

7. Wiring the device



Electric shock may result in serious injury or death. Follow all warnings in this guide and on the product while working in accordance with the latest electrical safety practices. Connecting the Diginet DALI Relay to a DALI line must be carried out by a suitably qualified installer who must work in accordance with standard safety procedures for mains-powered electrical equipment.

To operate correctly, the one channel and two channel relay devices must be connected to 240Vac mains and a DALI line, as shown below.

One Channel Relay Device

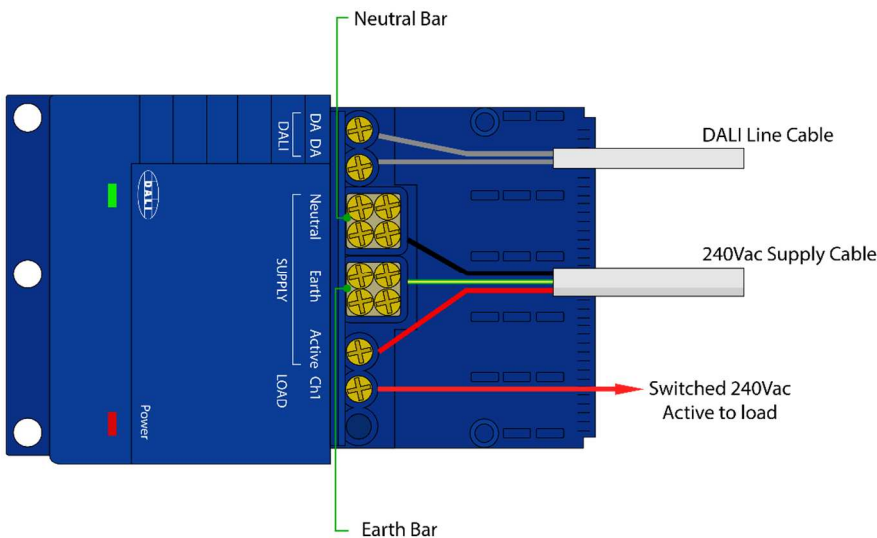

Two Channel Relay Device

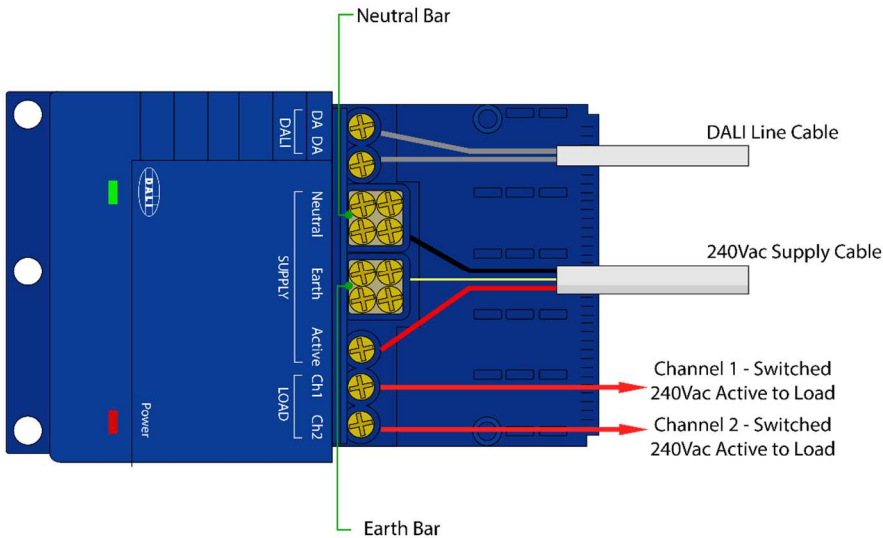

Note

- The switched load (Active) output is internally connected via the Active mains supply connection. The relays are not 'voltage-free' type.
- The mains supply earth connection is optional and is not internally connected to the device. Only the 240Vac Active & Neutral connections are required, however if a 3-core cable with Earth conductor is used, the included Earth bar can be used to loop the Earth off to other devices.
- If required, the Neutral and Earth bars can be used to loop off 3-core cables to the load (together with the switch Active output cable).

Cable entry tabs/knockouts for 1.5mm² and 2.5mm² cables

The terminal cover includes a series of cable entry tabs/knockouts for use with typical 1.5mm² and 2.5mm² Flat TPS/building cable.

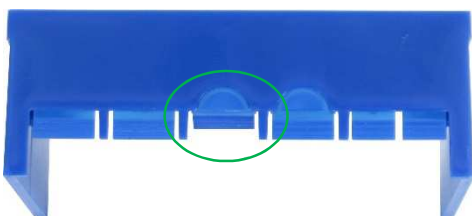
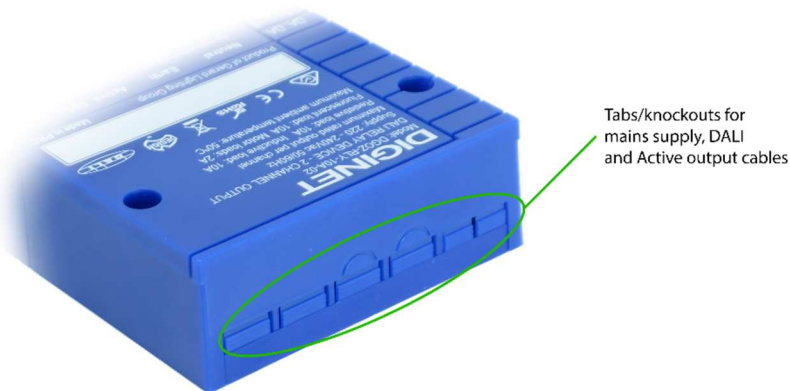

Tab pushed backwards to accommodate 1.5mm² cable

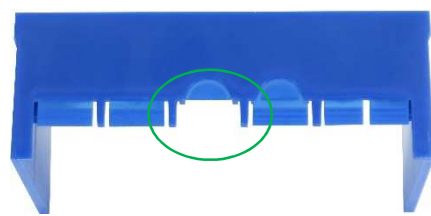

Tab removed to accommodate 2.5mm² cable

Using cable ties to secure DALI mains supply and switched Active output cables

The base of the cable termination area in the DALI relay device includes a series of slots for cable tying cables, as required. A series of knockouts for cable ties are also provided, should more cable tie locations be required. (Note, six cable ties are included in the relay packaging).

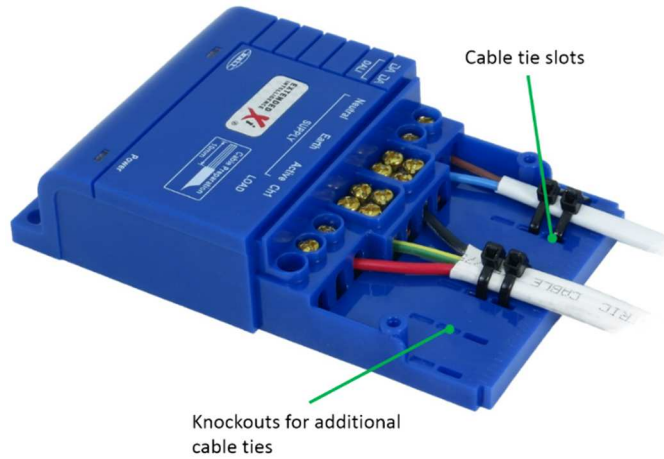
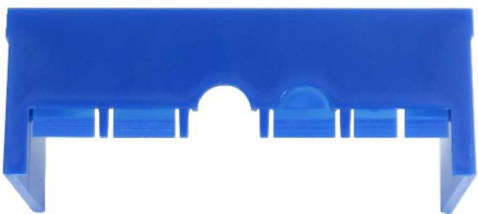

Figure x – Fixing cables in termination area using the provided cable ties

5-Core modular wiring cable

The device is suitable for connected to mains and DALI using 5-core modular wiring cable. A knockout is provide in the terminal cover to allow the use of circular 5-core cable.



Circular knockout removed to accommodate 5-core modular wiring cable



DALI Relay Device connected to a 5-core cable and modular wiring connector

8. LED Status Indicators

| DALI LED Indicator (green) | |
|--|--|
| State | Meaning |
| Indicator ON and fast-blink off once every 2 seconds | DALI OK |
| Indicator ON and multiple fast-blinks | DALI communications |
| Indicator OFF and fast-blink on once every 2 seconds | Device is functional, but no DALI Line voltage present |
| Power LED indicator (red) | |
| State | Meaning |
| Indicator ON | Mains power connected correctly |
| Indicator OFF | No mains connected |

9. Configuring the device

To operate correctly, the DALI relay Device must be programmed with the appropriate DALI addressing. Depending on the application of the device, the following parameters may be required to be configured

- DALI Short Address
- DALI Group Address(s)
- DALI Scene Address(s)
- Minimum Level and Maximum Level
- Power On Level and System Failure Level (*Note: Diginet **RAPIX Addressing** software configures these parameters as global parameters across all control gear on a DALI Line*)
- Fade Time and Fade Rate (*Note: Diginet **RAPIX Addressing** software configures these parameters as global parameters across all control gear on a DALI Line*)

These parameters can be configured using Diginet **RAPIX Addressing** software, or any other DALI software which allows these standard DALI parameters to be configured in a DALI Compliant Relay device.

10. Output state on Power-up

When mains power is connected to a DALI relay device, by default the relay outputs will automatically go to the ON state.

The Power ON state can be changed from the default behaviour via the DALI network using Diginet's **RAPIX Addressing** software or other DALI commissioning software that has the ability to change the DALI standard 'Power ON Level' parameter.

Diginet's **RAPIX Addressing** software supports the ability to set the DALI relay *Power On Level* to ON (default), Off or restore to previous level (i.e., before mains was lost).

11. Output state if DALI communications is lost

If DALI communications is lost to a DALI relay device, by default the relay outputs will automatically go to the ON state.

The output state when DALI communications is lost can be changed from the default behaviour via the DALI network using Diginet's **RAPIX Addressing** software or other DALI commissioning software that has the ability to change the DALI standard 'System Failure Level' parameter.

Diginet's **RAPIX Addressing** software supports the ability to set the DALI relay *System Failure Level* state to ON (default), Off or restore to previous level (i.e., before DALI communications was lost).

12. Product specifications

| | 1 Channel Relay | 2 Channel Relay |
|--|---|-----------------|
| Item Number | DGOZ-RLY-10A-01 | DGOZ-RLY-10A-02 |
| Number of outputs | 1 | 2 |
| Nominal Mains Supply Voltage | 220 – 240V ac | |
| Mains Frequency Range(s) | 47 – 63 Hz | |
| Electrical Isolation | 3.75kV (DALI to Mains) | |
| Status Indicators | Mains (red LED) DALI (green LED) | |
| Max. Number of Units on a single DALI line | 64 | |
| Load Rating | Resistive 10A per channel Inductive 10A per channel Fluorescent 10A per channel Motor 2A per channel | |
| Relay Switch Operations | >50,000 operations at rated load | |
| Relay Contact Type | Bifurcated High Inrush | |
| Standby Power | <500mW | |
| Dimensions | See separate Diagram | |
| Mains Terminals | 2 x 2.5mm ² maximum per terminal or 3 x 1.5mm ² maximum per terminal | |
| DALI Terminals | 2 x 2.5mm ² maximum per terminal or 3 x 1.5mm ² maximum per terminal | |
| Weight | 160g | 175g |
| Operating Temp. Range | 0-50°C | |
| Operating Humidity Range | 95% < 95% RH non condensing | |
| Mounting Arrangement | Surface mount via 6mm mounting holes , DIN rail mounting (with optional DIN rail mounting bracket) | |
| Housing Material type | Flame Retardant Polycarbonate | |
| IP Rating | IP20 | |
| Compliance Marks | CE, RMC, DALI | |

13. Product dimensions

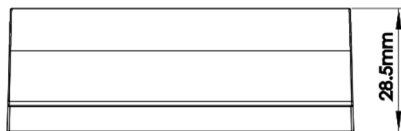
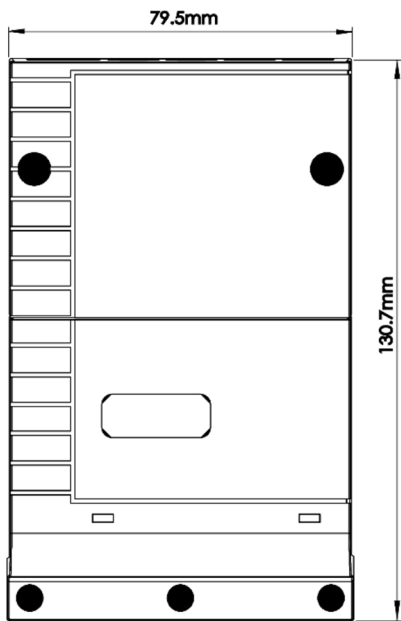

Dimensions – DALI Relay Device

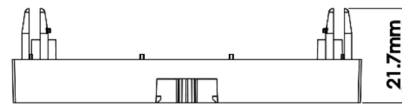
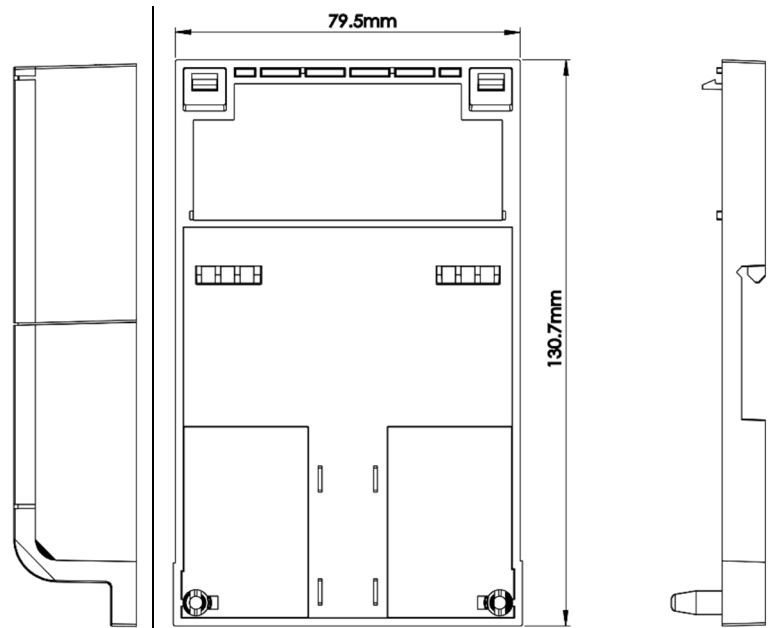

Dimensions – Optional Mounting Bracket

14. Standards and compliance

This one channel and two channel relay devices are designed to meet/exceed the following Australian and International standards:

Australian/New Zealand EMC and Electrical Safety Frameworks and Standards

| Regulation | Standard | Title |
|-------------------|---|--|
| EMC | IEC 60669-2-1 EN 60669-2-1 AS/NZS 60669.2.1 | Switches for household and similar fixed electrical installations - Part 2-1: Particular requirements - Electronic switches. (EMC clauses) |
| | IEC 61000-3-2, -3 EN 61000-3-2, -3 AS/NZS 61000-3-2, -3 | Limits for harmonic current emissions. Limitation of voltage changes, voltage fluctuations and flicker. |
| | IEC 61000-4-2, -3, -4, -5, -6, -8, -11 | ESD, Radiated Immunity, EFT/Burst, Surge, Conducted Immunity, Magnetic Immunity, Voltage dips and Short Interruptions. |
| | AS/NZS CISPR 15 | Limits and methods of measurement of radio disturbance characteristics of electrical lighting and similar equipment |
| Electrical Safety | IEC 60669-2-1 EN 60669-2-1 AS/NZS 60669.2.1 | Switches for household and similar fixed electrical installations - Part 2-1: Particular requirements - Electronic switches (Safety clauses) |

| EC Council Directive | Title |
|----------------------|---|
| 2006/95/EC | Low Voltage |
| 2004/108/EC | Electromagnetic Compatibility (EMC) |
| 2011/65/EU | Restriction of Hazardous Substances (RoHS) in Electrical and Electronic Equipment |

Other International Directives and Standards

| Regulation | Standard | Title |
|---|---------------|---|
| Digital Addressable Lighting Interface (DALI) | IEC 62386-101 | Digital Addressable Lighting Interface – Part 101: General Requirements – System |
| Digital Addressable Lighting Interface (DALI) | IEC 62386-102 | Digital Addressable Lighting Interface – Part 102: General Requirements – Control Gear |
| Digital Addressable Lighting Interface (DALI) | IEC 62386-207 | Digital Addressable Lighting Interface – Part 207: Particular Requirements for Control Gear – LED modules (device type 6) |

15. Product warranty

This Diginet One Channel and two Channel DALI Relay Devices, item numbers DGOZ-RLY-10A-01 and DGOZ-RLY-10A-02 have a two-year warranty against manufacturing defects in accordance with the following terms:

1. Nothing in this Warranty affects any person's rights under the Australian Consumer Law. The benefits to any person under the Gerard Lighting Warranty are in addition to the rights and remedies available under any Consumer Guarantees.
2. Subject to the other clauses of this Warranty, Gerard Lighting warrants that the Goods will be free of manufacturing defects and will perform to Gerard Lighting's specifications.
3. The benefit of the Gerard Lighting Warranty extends only to the owner of the property in which the Goods are installed (the Owner) for five (5) years after the date of purchase (Warranty Period).
4. If within the Warranty Period the Goods fail to perform to Gerard Lighting's specifications as a result of some defect in material or workmanship in the Goods (Defect) then Gerard Lighting will, at its option, repair the Goods or supply replacement Goods free of charge.
5. The Gerard Lighting Warranty will not apply to Goods:
 - 5.1. installed by any person other than a qualified tradesperson; or
 - 5.2. subjected to misuse, neglect, negligence or accidental damage; or
 - 5.3. operated in any way contrary to any operating or maintenance instructions; or
 - 5.4. improperly handled, installed or maintained; or
 - 5.5. altered or modified prior to or after installation.
6. The Gerard Lighting Warranty does not apply to faulty or defective design of Goods unless Gerard Lighting has designed the Goods and Gerard Lighting expressly accepts responsibility for such design in writing.
7. In order to make a claim under the Gerard Lighting Warranty, the Owner must:
 - 7.1. contact Gerard Lighting to obtain a Returned Goods Authorisation Number for the Goods and to be notified of Gerard Lighting's return address for the Goods by:
 - 7.1.1. freecall **1300 95 DALI (3254)**; or
 - 7.1.2. post to **PO Box 314, Padstow NSW 2211**; or
 - 7.1.3. fax to **1300 95 3257**; or
 - 7.1.4. email to sales@diginet.net.au.
 - 7.2. return the Goods at the Owners expense to the return address notified by Gerard Lighting together with all accessories, instructions, specifications or other material supplied with the Goods and a notice in writing:
 - 7.2.1. stating the Returned Goods Authorisation Number for the Goods;
 - 7.2.2. describing in detail the defect or fault in the Goods;
 - 7.2.3. setting out the Owner's contact details (including postal address, email address and telephone numbers at which the Owner can be contacted during usual business hours).
 - 7.3. Gerard Lighting will not accept any returned Goods which have not been returned strictly in accordance with the above instructions.
8. Gerard Lighting will examine any returned Goods and if Gerard Lighting determines that they are defective through no fault of the Owner and are otherwise undamaged, Gerard Lighting will repair or replace the Goods free of charge.
9. Gerard Lighting will notify the Owner whether it accepts the Goods are defective within a reasonable time of return.
10. Gerard Lighting will not be responsible for any costs of de-installation, re-installation, returning Goods or for redelivery of the Goods (whether original or repaired and/or replacement Goods) by Gerard Lighting and any other related expenses of the Owner in claiming under the Gerard Lighting Warranty.
11. Gerard Lighting will not be responsible for any loss or damage to the Goods occurring while the Goods are in transit (either on return to Gerard Lighting or upon redelivery to the Owner of the original or repaired and/or replacement Goods).
12. Gerard Lighting will not be responsible (whether arising in contract or tort (including negligence) or under any statute) for any special, indirect, incidental, consequential or economic losses or damages (including loss of data, business, profits, revenue, anticipated savings, bargain, opportunity or goodwill) whether or not the possibility of those losses or damages being suffered had been brought to the attention of Gerard Lighting.

The Australian Consumer Law requires the inclusion of the following statement with the Gerard Lighting Warranty:

Our goods come with guarantees that cannot be excluded under the Australian Consumer Law. You are entitled to a replacement or refund for a major failure and for compensation for any other reasonably foreseeable loss or damage. You are also entitled to have the goods repaired or replaced if the goods fail to be of acceptable quality and the failure does not amount to a major failure.



Gerard Lighting Pty Ltd (Gerard Lighting) reserves the right to alter the specifications, designs or other features of any items and to discontinue any items at any time without notice and without liability. While every effort is made to ensure that all information in this user and installation guide is correct, no warranty of accuracy is given and Gerard Lighting shall not be liable for any error.

Trademarks

The identified trademarks and copyrights are the property of Gerard Lighting unless otherwise noted.

© Copyright

This user and installation guide is copyright to Gerard Lighting. Except as permitted under relevant law, no part of this user and installation guide may be reproduced by any process without written permission of and acknowledgement to Gerard Lighting.

June 2015

Printed on recycled paper

DIGINET.NET.AU

Product of Gerard Lighting Pty Ltd

ABN – 89 095 788 864

96-112 Gow Street

Padstow NSW 2211

Contact

General Enquiries: 1300 95 DALI (3254) or sales@dignet.net.au

Technical Services: 1300 95 3244 or support@dignet.net.au

Fax: 1300 95 3257

Dignet is a brand of Gerard Lighting